



PRODUCT DATASHEET

Bridget series

last update 18/10/2013

DETAILS

Product Number	C13556_BRIDGET-M-UNI
Family	Bridget
Type	Reflector
Color	metal
Diameter	22.6 mm
Height	12.8 mm
Style	hexag
Optic Material	PC
Holder Material	
Fastening	glue
Status	ready
ROHS Comliant	Yes
Date Updated	20/08/2014



OPTICAL PROPERTIES

LED	Viewing Angle	Light Beam	Efficiency	cd/lm	connector
Soleriq P6	35 degrees		80 %	1.660	-
CXA15xx	47 degrees		84 %	1.200	-
BXRA ES Star	48 degrees		84 %	1.200	-
Mini Zenigata (GW5BM)	49 degrees		84 %	1.200	-
Soleriq P9	50 degrees		84 %	1.200	-
CLL02x	52 degrees		84 %	1.100	-

Relative intensity of C13556_BRIDGET-M-UNI_(So

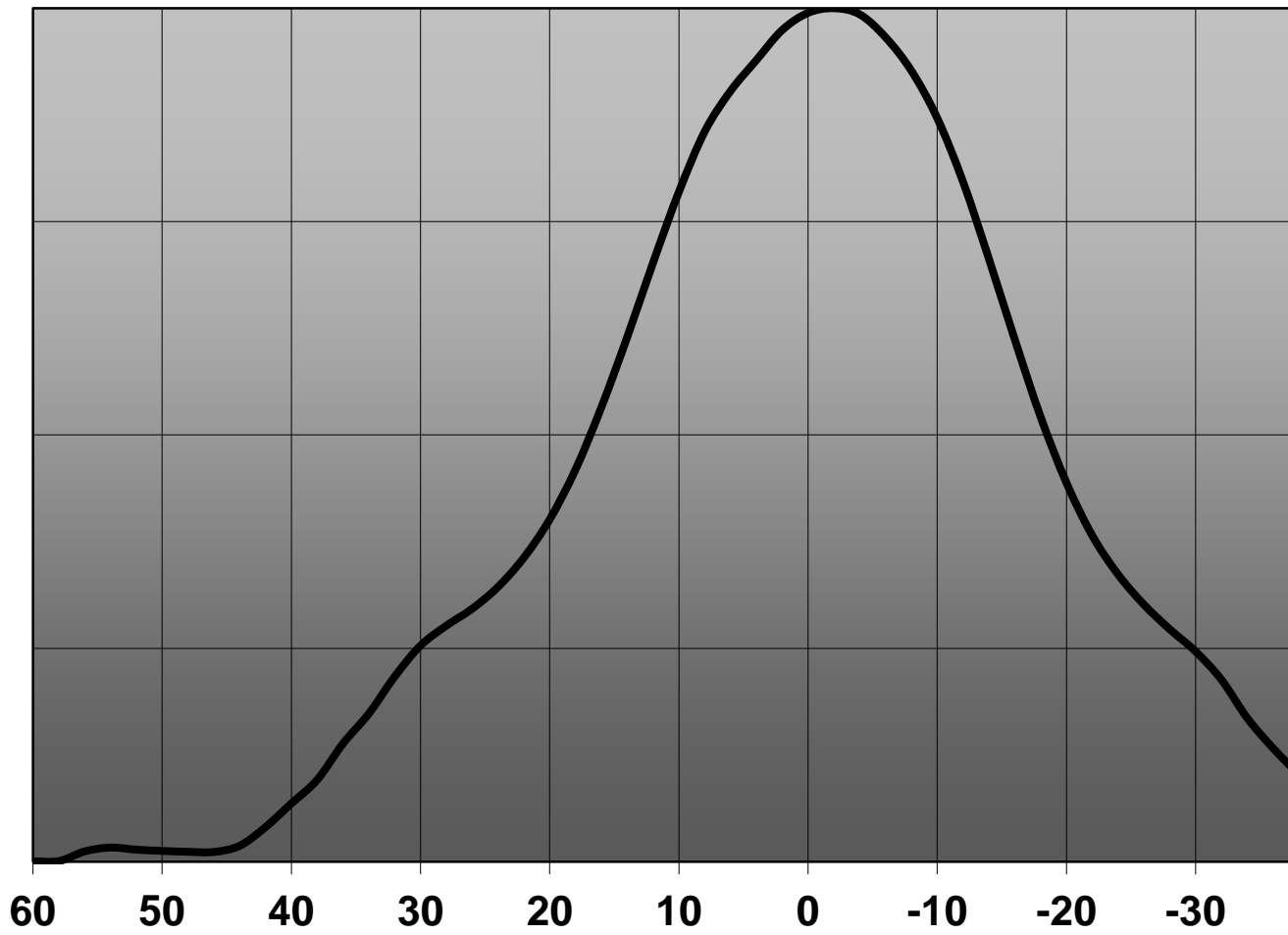

Relative intensity of C13556_BRIDGET-M-UNI_(So

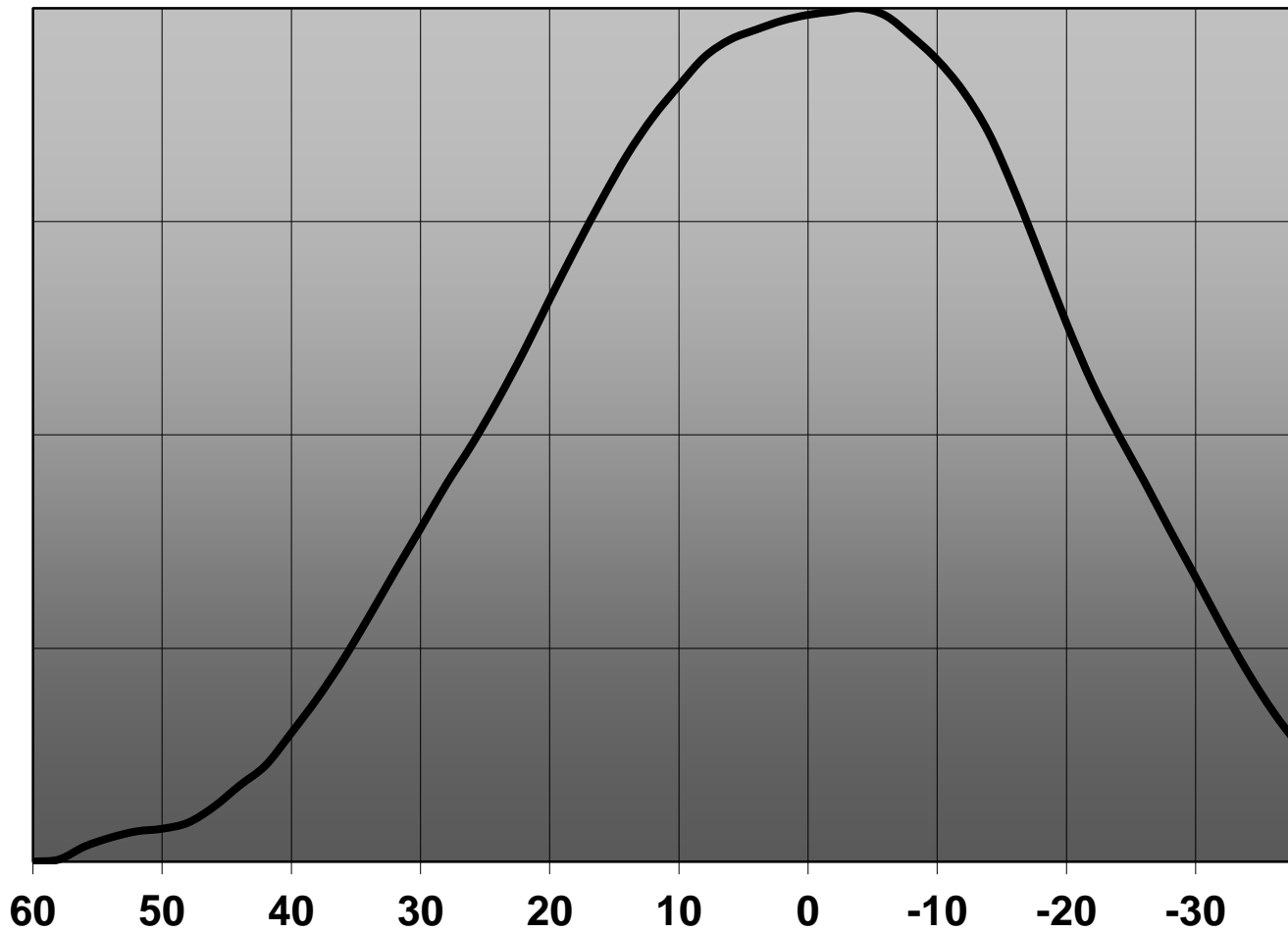

D

C

B

A

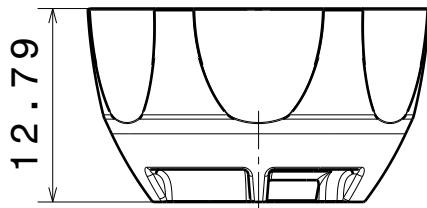

Front view

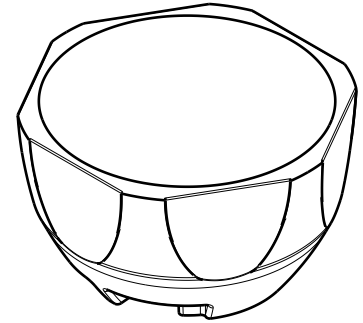

Isometric view

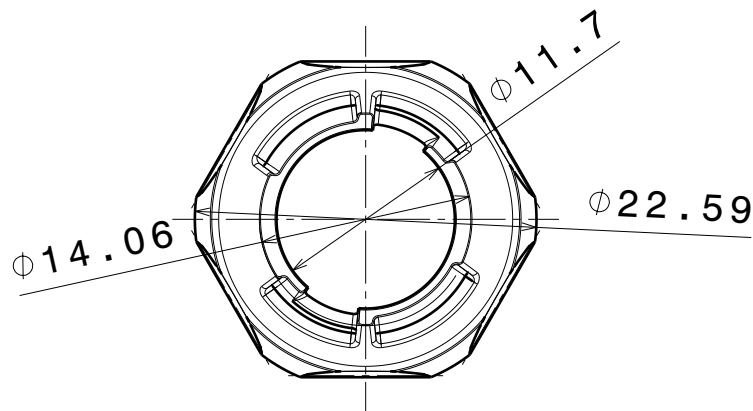

Bottom view

Tolerances if not otherwise shown
According to DIN ISO 2768-1
Linear measures:
Up to 30mm class F, otherwise class M.
According to DIN ISO 2768-2
Form and position: class K

LEDiL

Ledil Oy
Salorankatu 10
FIN 24240 SALO
Finland

THIRD ANGLE PROJECTION:

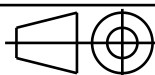

DRAWING TITLE

BRIDGET_UNI_Datasheet

This drawing is the property
of LEDiL Oy. It may not be
reproduced, copied or
communicated without a written
agreement with LEDiL Oy."

SIZE

A4

PART NUMBER

-

4

4

3

3

2

2

1

1

Luminaire: LEDil Oy C13556_BRIDGET-M-UNI_(CXA15) Efficiency=84%

Lamps: 1 x Cree CXA15 (CXA1507-30F-F2-N0A-00000) 218lm @ 50mA CCT=3100K P=1.7W I=50mA

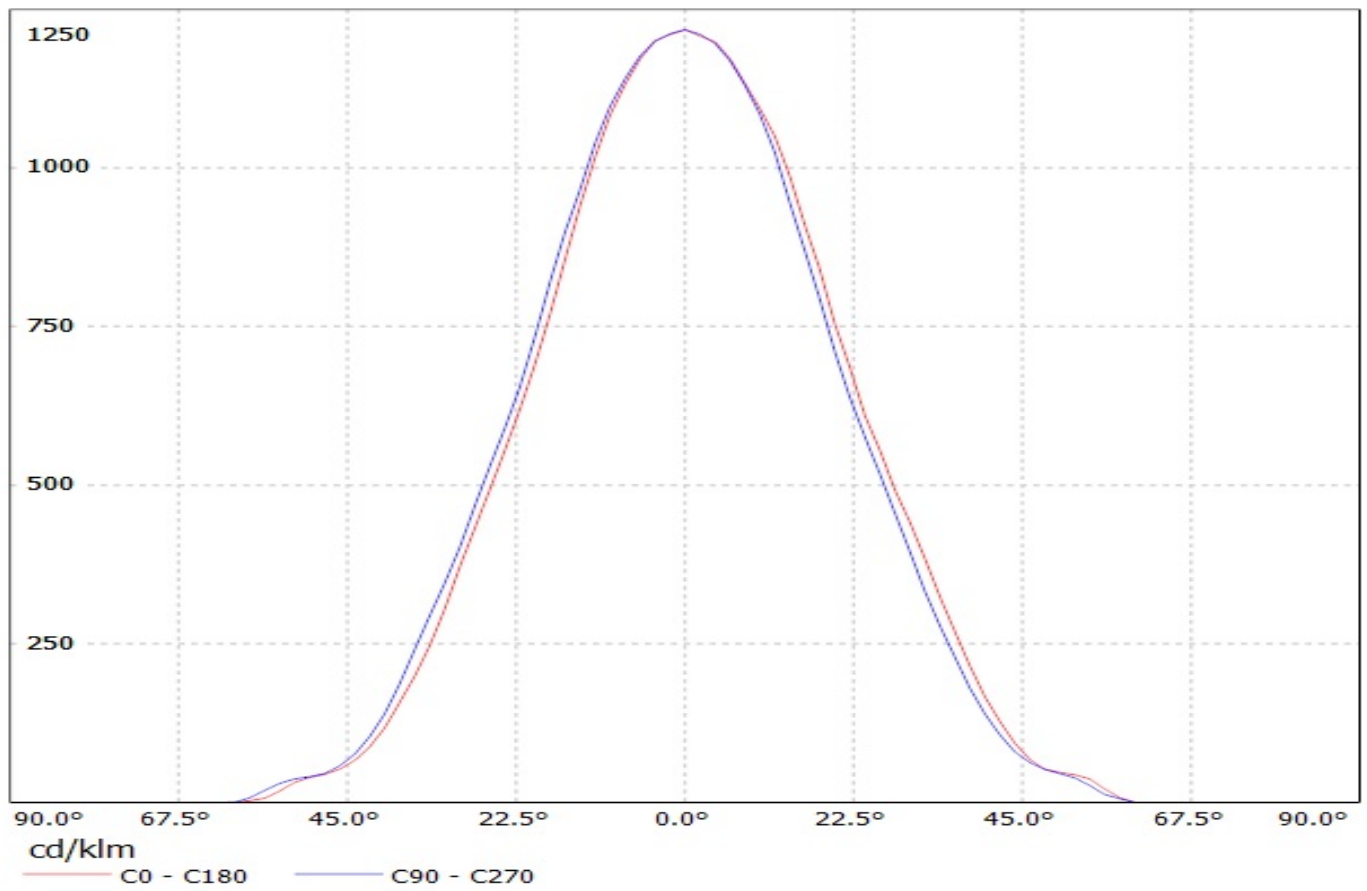

Luminaire: LEDil Oy C13556_BRIDGET-M-UNI_(BXRA_ES_STAR) Efficiency=84%

Lamps: 1 x Bridgelux BXRA ES Star (C0402) 203lm @ 250mA CCT=7300K P=2.2W I=250mA

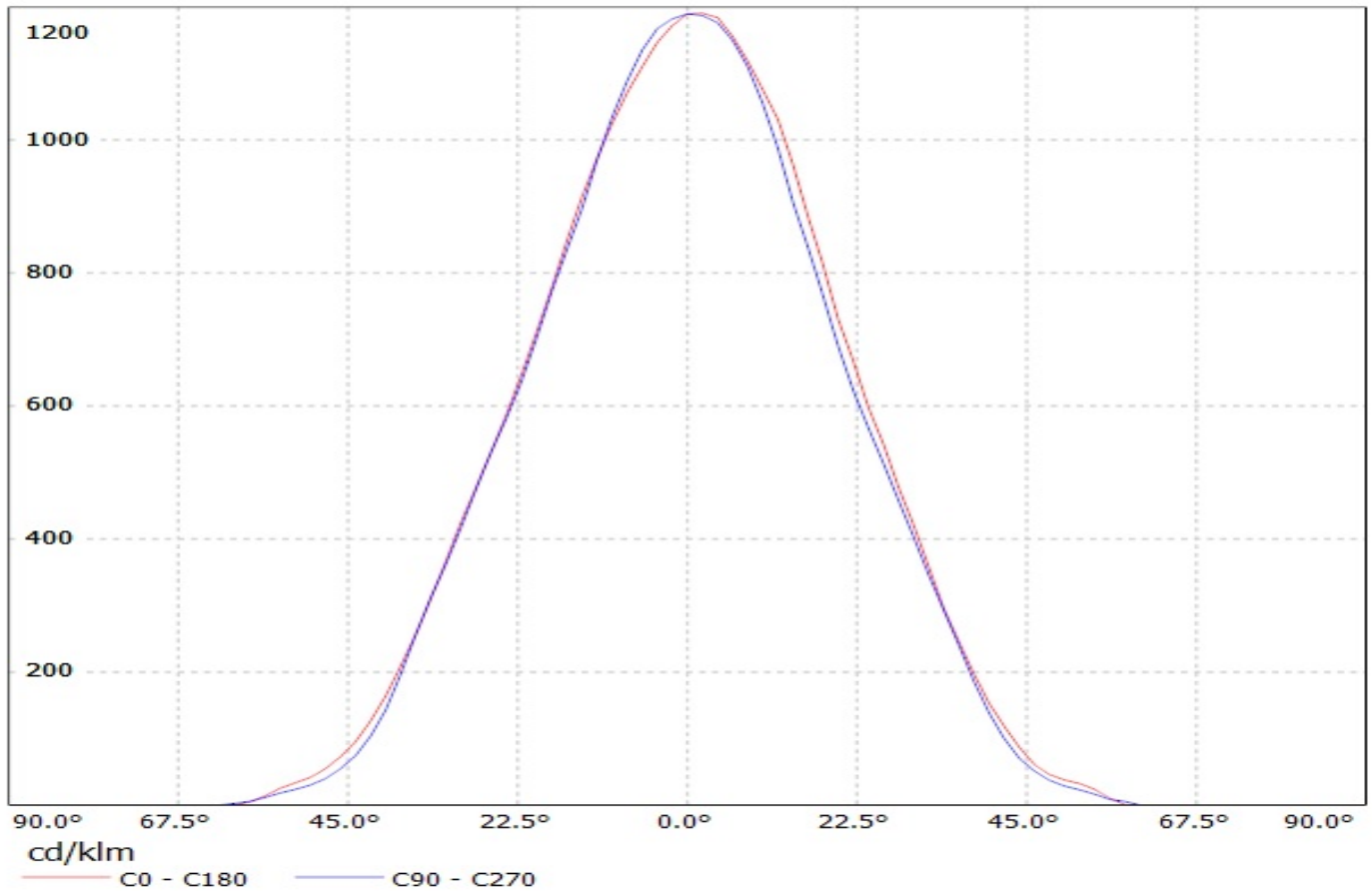

Luminaire: LEDil Oy C13556_BRIDGET-M-UNI_(Mini_Zenigata_GW5BJT) Efficiency=84%
Lamps: 1 x Sharp Mini Zenigata (GW5BTJ) 378lm @ 250mA CCT=4100K P=4.5W I=250mA

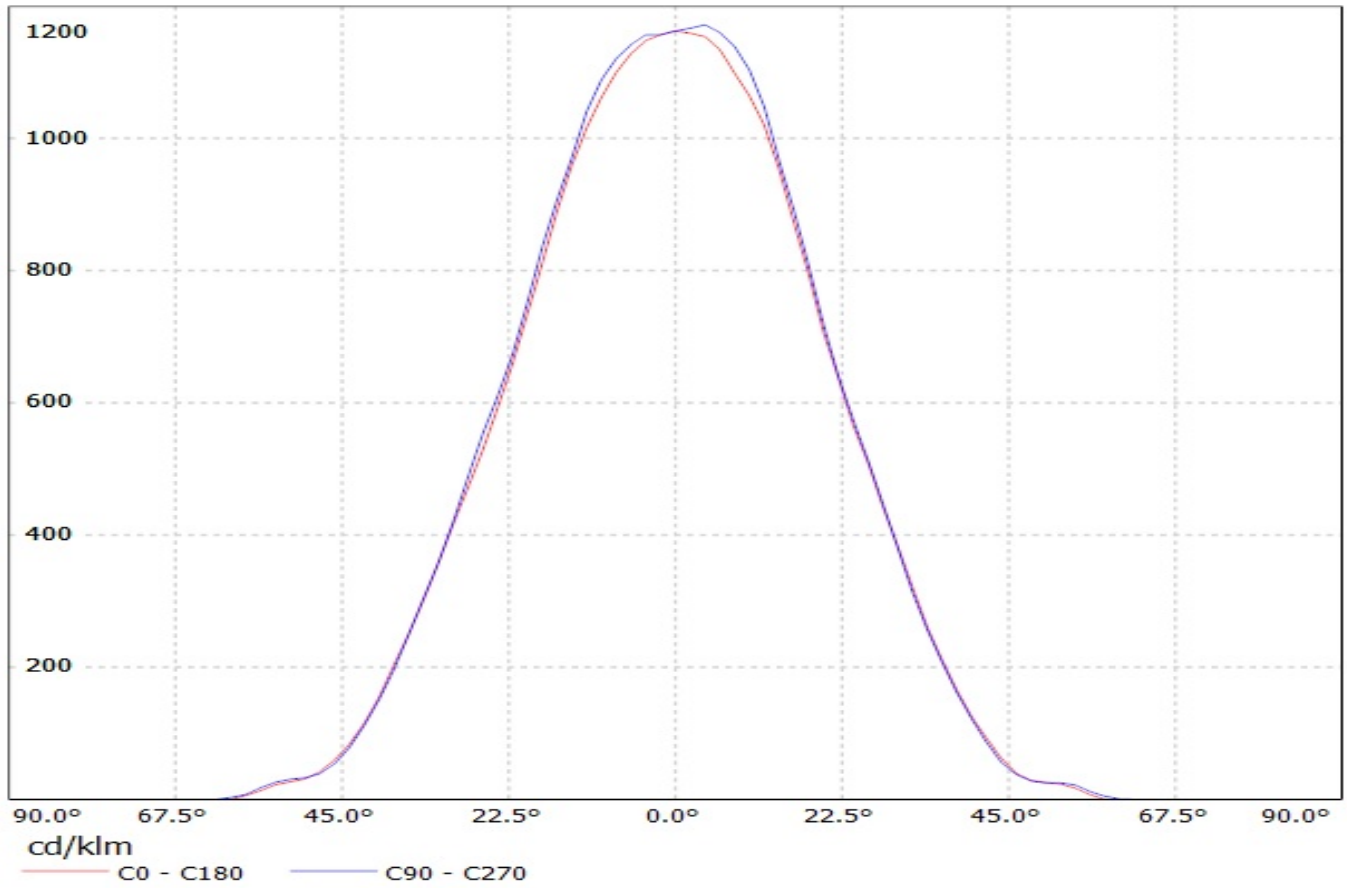

Luminaire: LEDil Oy C13556_BRIDGET-M-UNI_(CLL020) Efficiency=84%

Lamps: 1 x Citizen CLL020 (CLL020.1202A5-303H1A7) 515lm @ 250mA CCT=3000K P=9.3W I=250mA

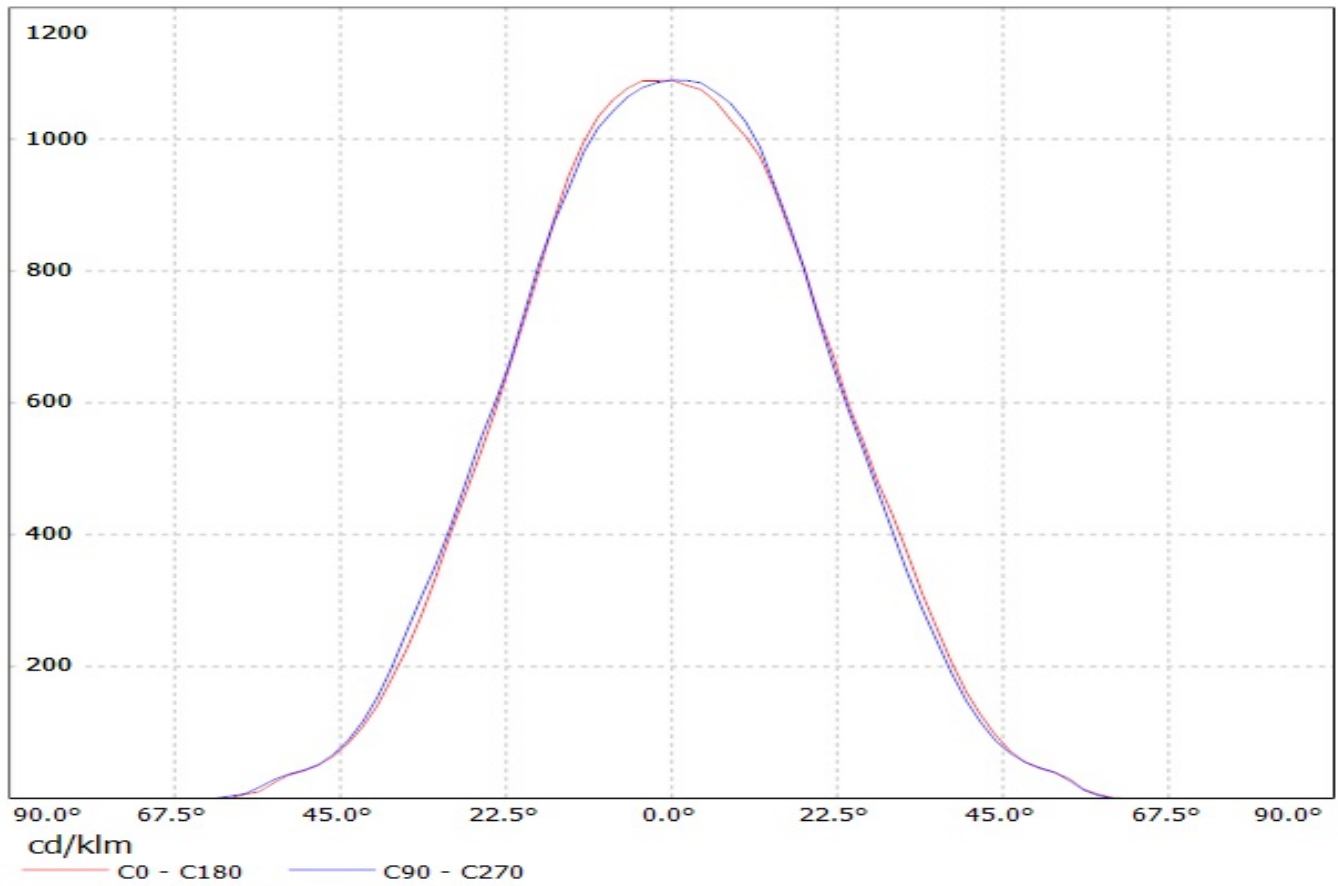

Luminaire: LEDil Oy C13556_BRIDGET-M-UNI_(CXA15) Efficiency=84%

Lamps: 1 x Cree CXA15 (CXA1507-30F-F2-N0A-00000) 218lm @ 50mA CCT=3100K P=1.7W I=50mA

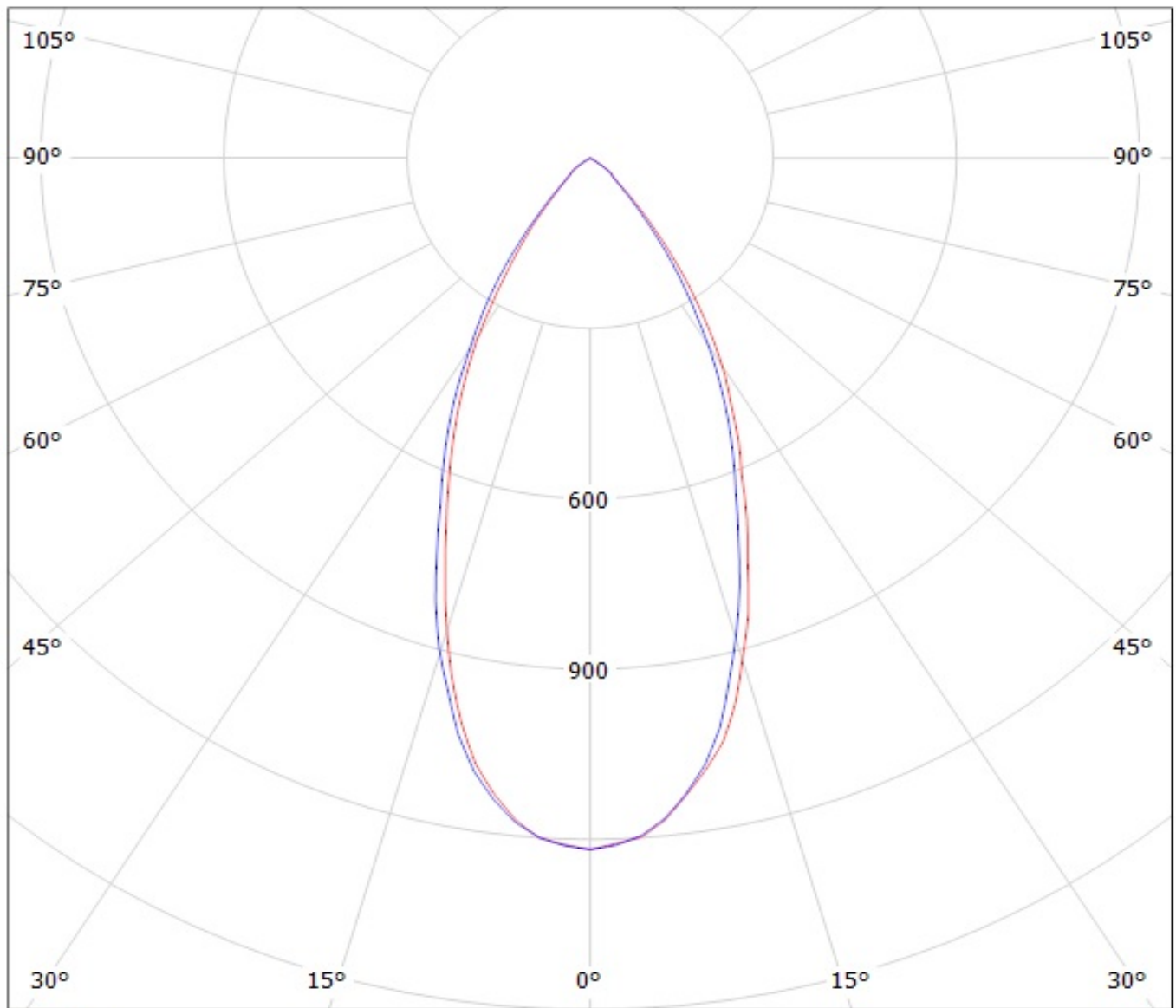

cd/klm

— C0 - C180

— C90 - C270

Luminaire: LEDil Oy C13556_BRIDGET-M-UNI_(BXRA_ES_STAR) Efficiency=84%

Lamps: 1 x Bridgelux BXRA ES Star (C0402) 203lm @ 250mA CCT=7300K P=2.2W I=250mA

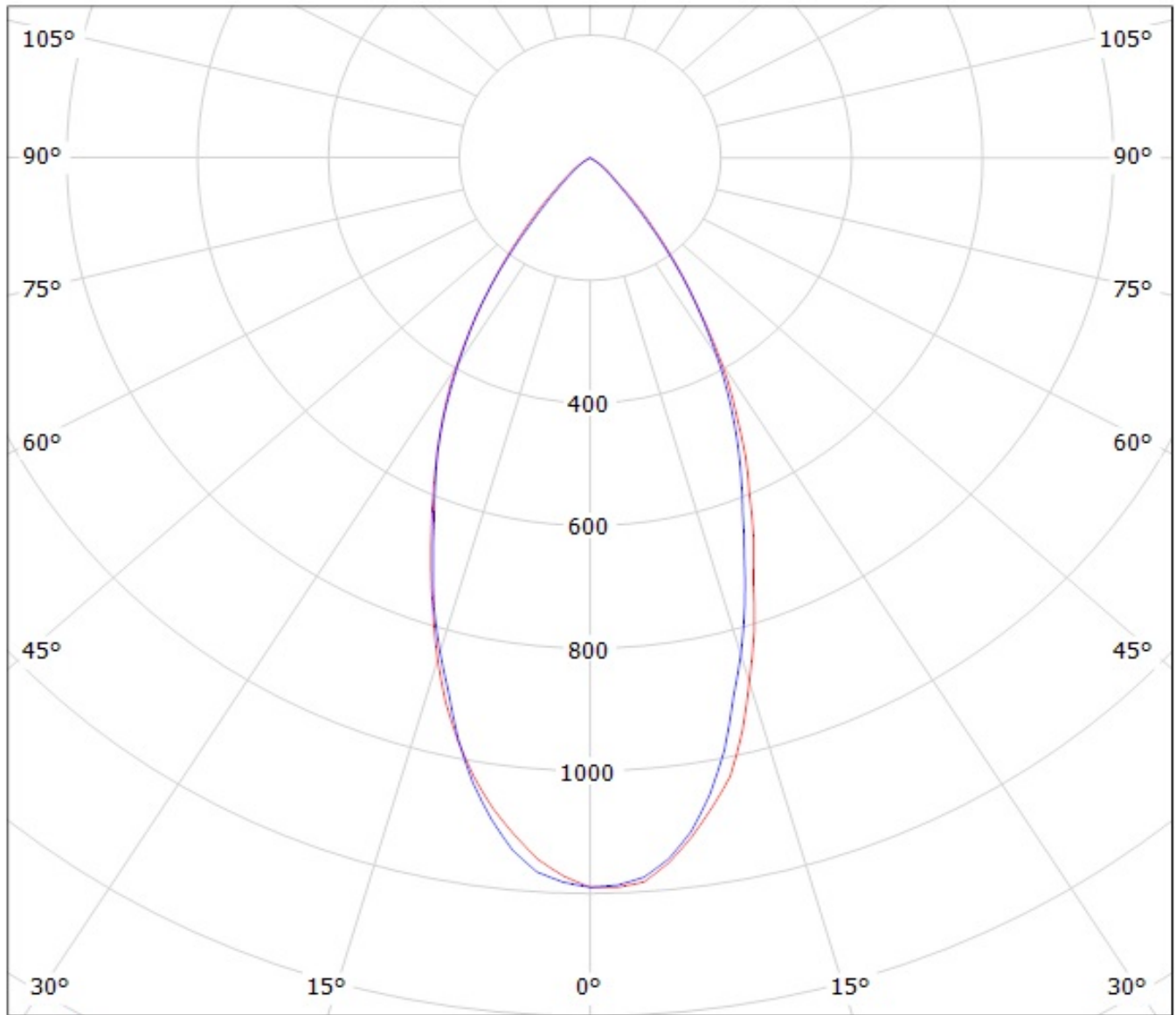

cd/klm

— C0 - C180

— C90 - C270

Luminaire: LEDil Oy C13556_BRIDGET-M-UNI_(Mini_Zenigata_GW5BJT) Efficiency=84%

Lamps: 1 x Sharp Mini Zenigata (GW5BTJ) 378lm @ 250mA CCT=4100K P=4.5W I=250mA

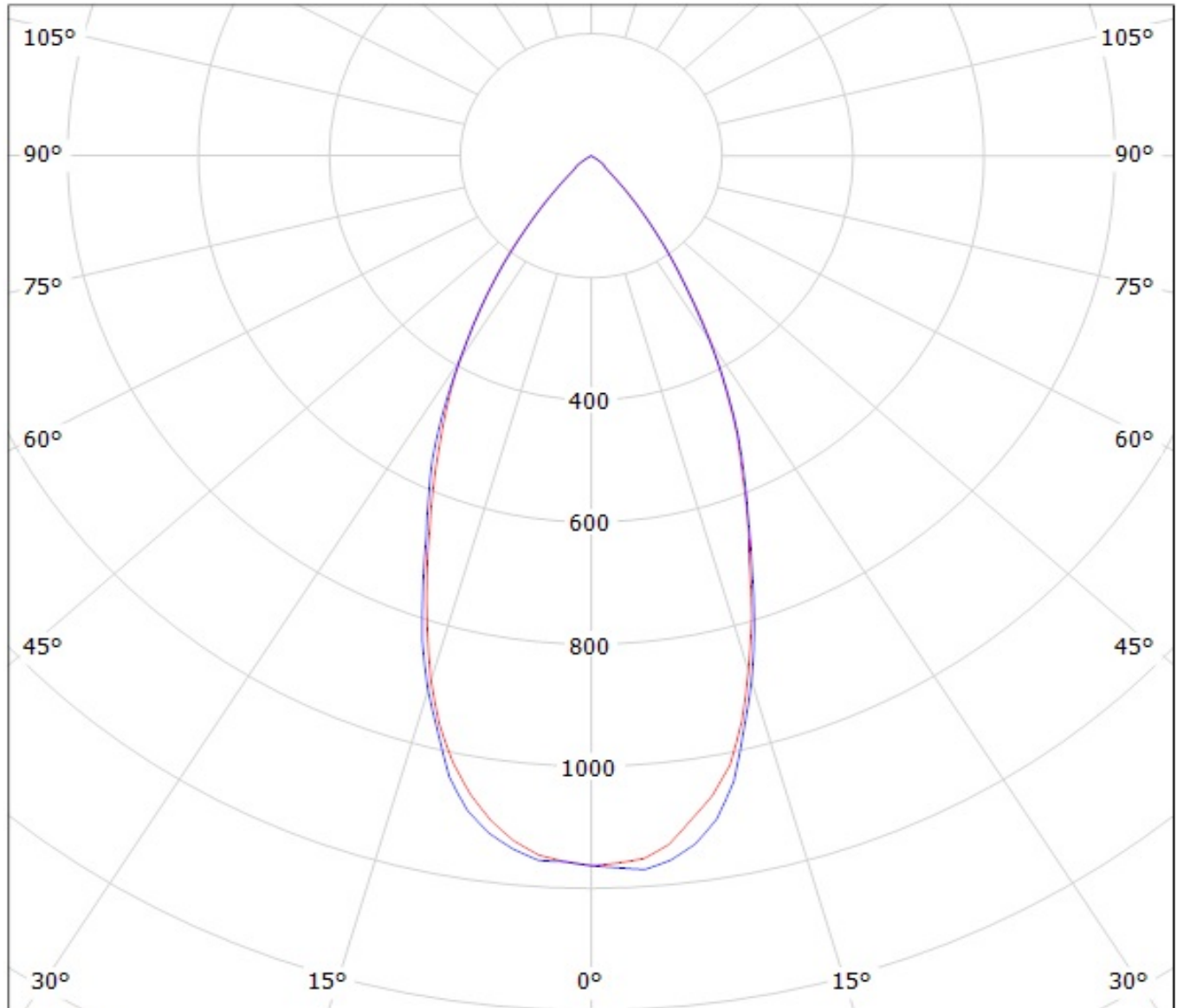

cd/klm

— C0 - C180

— C90 - C270

Luminaire: LEDil Oy C13556_BRIDGET-M-UNI_(CLL020) Efficiency=84%

Lamps: 1 x Citizen CLL020 (CLL020.1202A5-303H1A7) 515lm @ 250mA CCT=3000K P=9.3W I=250mA

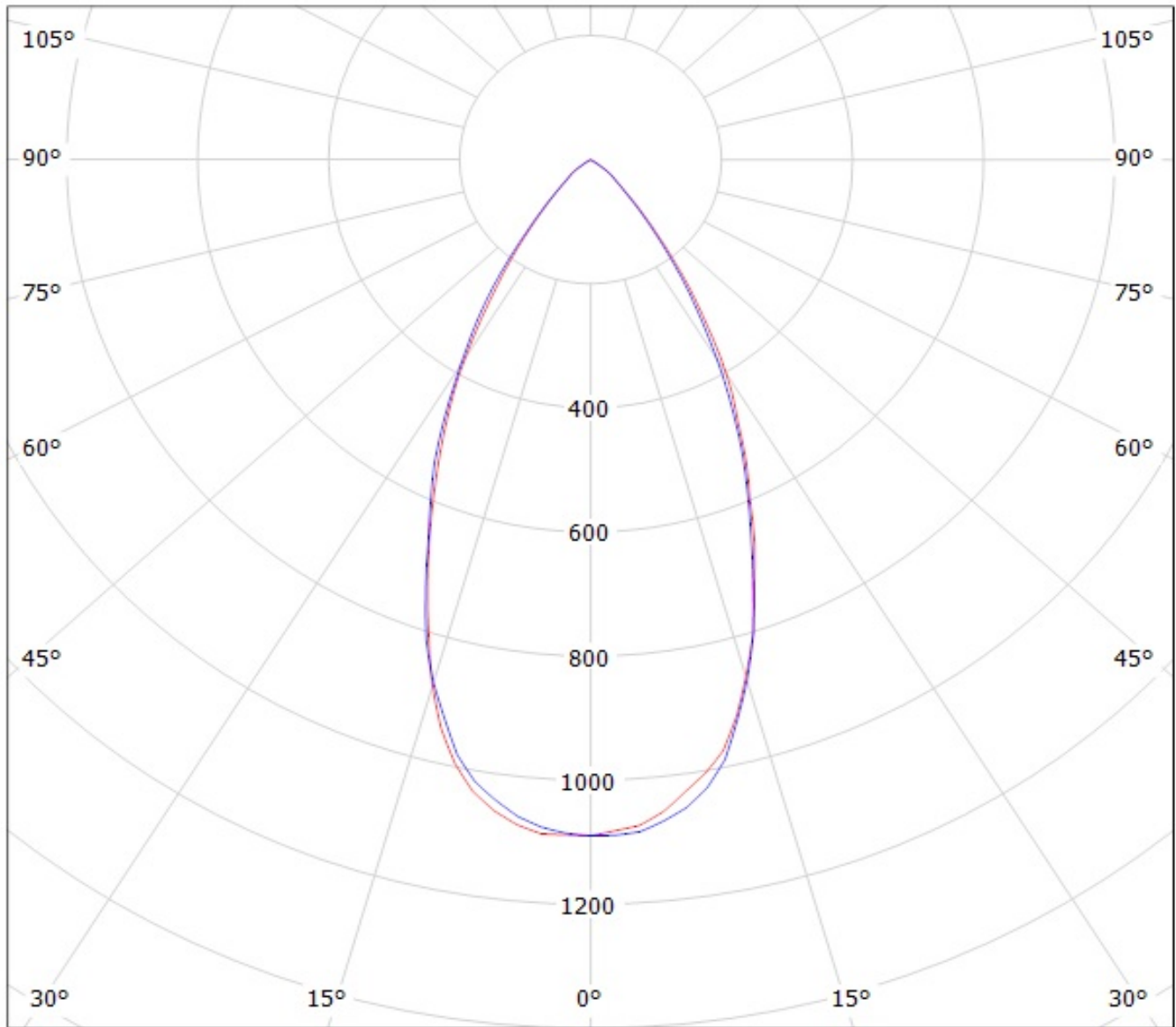

cd/klm

— C0 - C180

— C90 - C270

NOTE: The typical divergence will be changed by different color, chip size and chip position tolerance. The typical total divergence is the full angle measured where the luminous intensity is half of the peak value.

GENERAL INFORMATION

- Product series especially designed & optimized for series of LEDs.
- Special care taken to make light distribution as uniform as possible.
- Reflector is made of aluminium coated PC (120 degrees of Celcius / 248 degrees of Fahrenheit) with protective lacquer (short term 100 degrees of Celcius / 212 degrees of Fahrenheit).

- Fastening to PCB with appropriate adhesive. By clicking link below you can find Ledil recommended glue options.

http://www.ledil.com/datasheets/DataSheet_GLUES.pdf

Note! Due to use of high power COB's with this product, special attention to proper thermal design is highly recommended. LEDiL has no liability for direct, indirect or consecutive damages arising from the LEDiL products being used outside of the recommended temperature range.

NOTE 1: We advise customer to ensure the suitability and sufficiency of the bond in the end product. For example, mechanical stress, vibration and holes on the surface of the circuit board weaken the strength of the glue.

NOTE 2: All surfaces where glue is applied must be clean, dry and free from grease and dirt. If cleaning of PCB surfaces is needed, please follow strictly the cleaning instructions of your LED manufacturer -this is important as cleaning shall under no circumstances damage LEDs or other electronics components on the PCB.

Further note that optical components shall not be cleaned with any chemicals - only micro fiber cloth may be used to remove fingerprints or other traces from handling.