

NEW



PLUG IN SIM Card Connector
compatible to GSM 11.11 Standard

CONNECTOR

MB-0194-1

January 2009

SF8 Series

RoHS Compliant

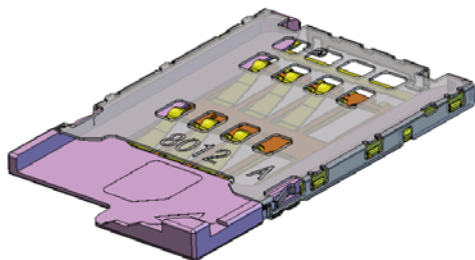

Standard

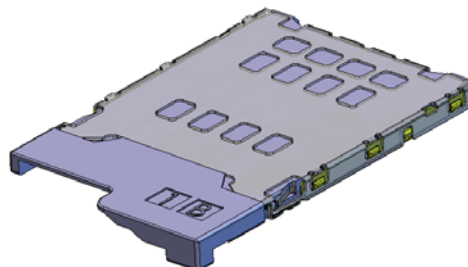

Reverse

SF8 Series is a tray type connector compatible with GSM 11.11 standard Plug in SIM card for GSM mobile phones.

(SIM: Subscriber Identification Module)

Features

- Tray type connector for GSM 11.11 standard Plug in SIM card
- Low profile structure, 1.55mm height, 16.65mm width, 19.3mm depth (26.2mm when card is inserted).
- Two types of mounting, normal (A type) and reverse (B type).
- Connector main body is provided in emboss (compatible to second reflow), tray provided in tray (tray is attached after mounting the main body).
- 4 portions of H/D ensures EMI/ESD countermeasure and gives consideration to prevention of instantaneous interruption caused by falling.
- Retention lock on tray provides click feeling when mated, and makes positioning easier and also prevents falling of tray.

General Specification

- | | |
|---|--|
| •No. of Contacts: 6pos. | •Rated Current: 10u A to 1A |
| •Contact Resistance: 100m ohm max. | •Insulation Resistance: 1000M ohm min. |
| •Dielectric Withstanding Voltage: AC500Vr.m.s 1minute | •Lifetime: 5000 times |
| •Operating Temperature: -40 Deg. C to +90 Deg. C | |

Materials and Finishes

Component	Material/Finish
Contact	Copper alloy/0.5u min. Au over Ni (contact area)
Housing	Glass filled LCP/none(UL94V-0)
Cover Frame	Stainless steel/none, Au plating over Ni (terminal portion only)
Tray	POM/none (UL94HB)

Ordering Information

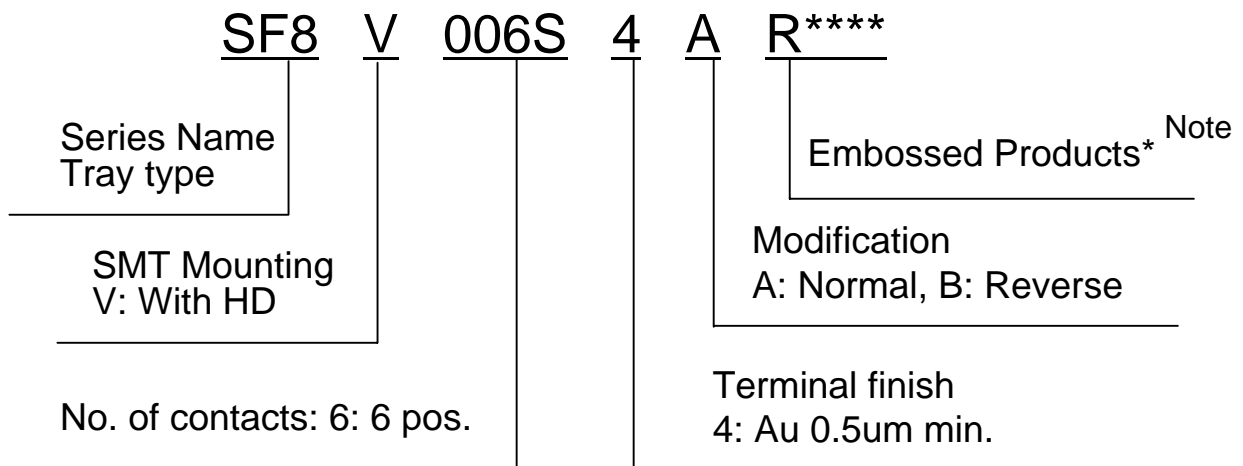

Note) Main body of connector is supplied in emboss, tray in tray packaging.
Please contact us for further information.

Please refer to JAHL-10578 for assembly and handling of connector and tray.

Part Number	SJ Drawing
SF8V006S4A (main body of connector)	SJ109314
SF8-STS1-A (Type A tray)	SJ109315

Standard
Mounting Type

Unit: mm

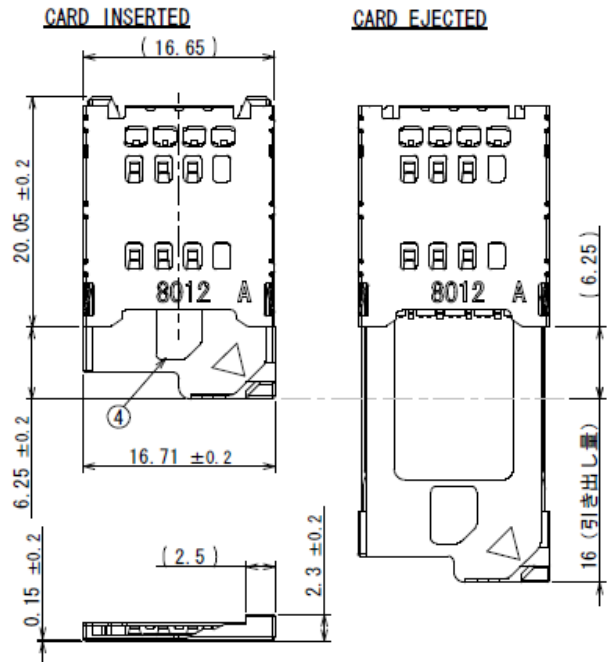
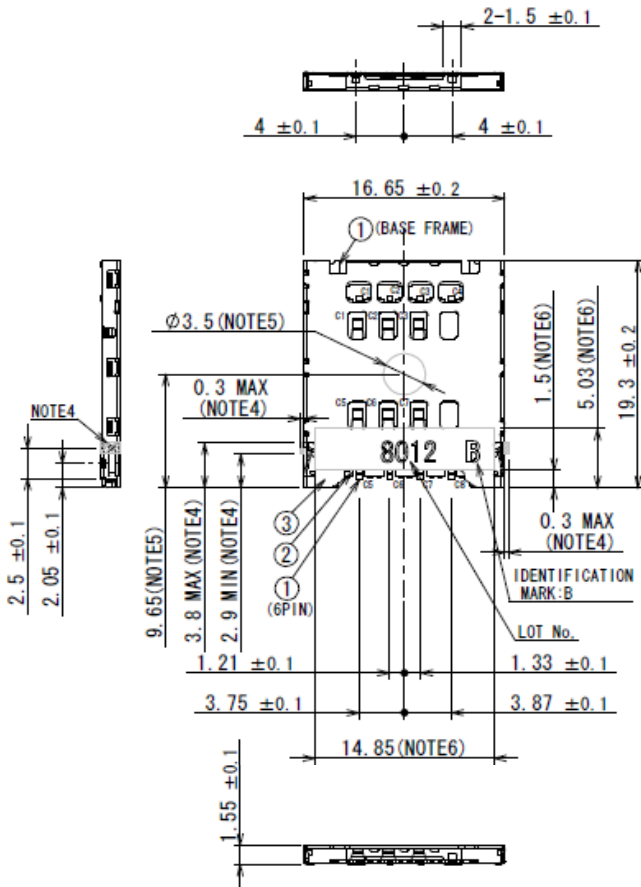

LOCATE THE PARTS (CASE)
170° MIN.
170° 以上になるように
筐体設定願います。

- NOTE1. NO PATTERN AND VIA HOLE SHOULD BE LOCATED IN THIS AREAS. BUT PATERN OF GND IS APPROVAL
- NOTE2. NO PATTERN AND VIA HOLE SHOULD BE LOCATED IN THIS AREAS.
- NOTE3. NO PATERN, VIA HOLE AND SOLDER RESIST IN THIS AREAS.
- NOTE4. NO PARTS LOCATED IN THIS AREA.
- NOTE5. VACUUM AREA
- NOTE6. LOT No. & IDENTIFICATION MARK AREA
- NOTE7. COPLANARITY SHOULD BE 0.1mmMAX.
- NOTE8. THE THICKNESS OF REINFORCEMENT BOARD IS 0.6MIN. WHEN THE PRODUCT WILL MOUNT ON FPC.

- 注1. パターン及びビアホール禁止エリアを示す。但し、GNDのパターンは可とする
- 注2. パターン及びビアホール禁止エリアを示す。
- 注3. パターン、ビアホール及びレジスト禁止エリアを示す。
- 注4. 部品搭載不可エリアを示す。
- 注5. 吸着エリア
- 注6. LOT No. 及び識別マークエリア (本品 : B)
- 注7. コプラナリティー=0.1mm以下とする。
- 注8. FPC搭載時の補強板厚は0.6以上とする。

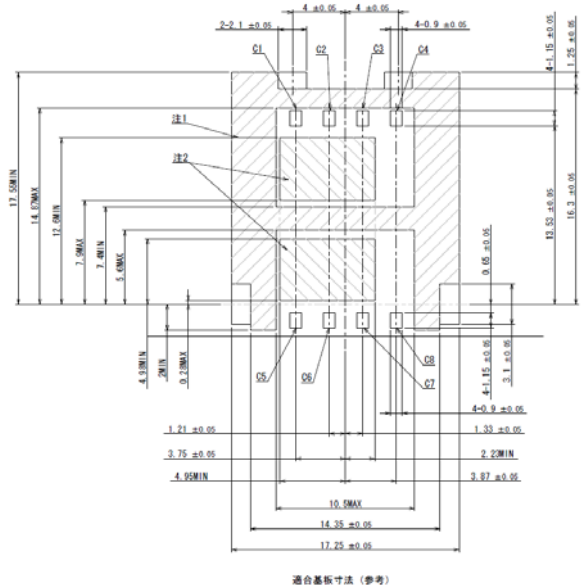

適合基板寸法 (参考)

APPLICABLE P. C. B. DIMENSION (REF)

Part Number	SJ Drawing
SF8V006S4B (main body of connector)	SJ109289
SF8-STR1-B (Type B tray)	SJ109290

Reverse Mounting Type

Unit: mm

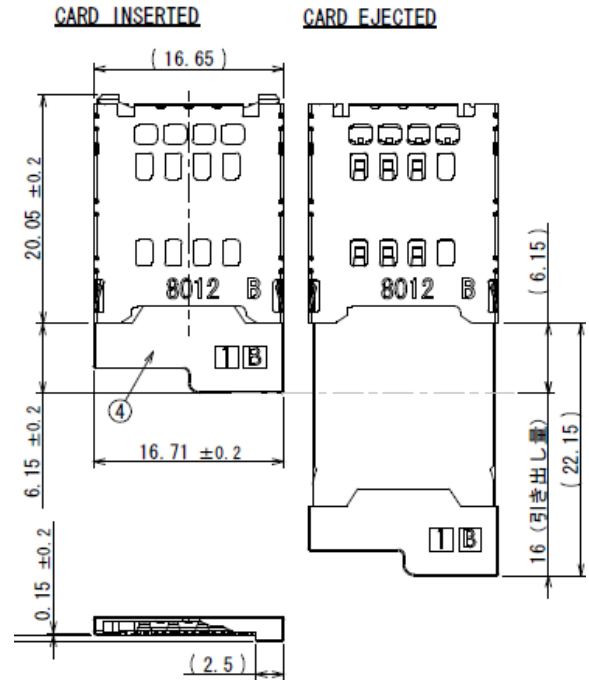
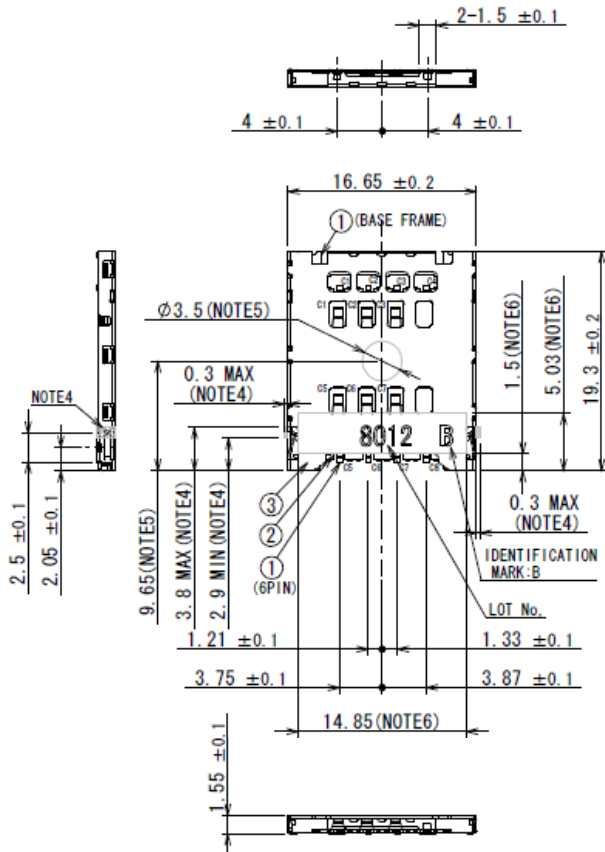

- NOTE1. NO PATTERN AND VIA HOLE SHOULD BE LOCATED IN THIS AREAS. BUT PATTERN OF GND IS APPROVAL
- NOTE2. NO PATTERN AND VIA HOLE SHOULD BE LOCATED IN THIS AREAS.
- NOTE3. NO PATTERN, VIA HOLE AND SOLDER RESIST IN THIS AREAS.
- NOTE4. NO PARTS LOCATED IN THIS AREA.
- NOTE5. VACUUM AREA
- NOTE6. LOT No. & IDENTIFICATION MARK AREA
- NOTE7. COPLANARITY SHOULD BE 0.1mmMAX.
- NOTE8. THE THICKNESS OF REINFORCEMENT BOARD IS 0.6MIN. WHEN THE PRODUCT WILL MOUNT ON FPC.

- 注1. パターン及びビアホール禁止エリアを示す。但し、GNDのパターンは可とする
- 注2. パターン及びビアホール禁止エリアを示す。
- 注3. パターン、ビアホール及びレジスト禁止エリアを示す。
- 注4. 部品搭載不可エリアを示す。
- 注5. 吸着エリア
- 注6. LOT No. 及び識別マークエリア (本品 : B)
- 注7. コプラナリティー0.1mm以下とする。
- 注8. FPC搭載時の補強板厚は0.6以上とする。

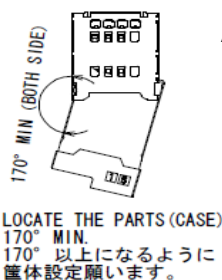

APPLICABLE P. C. B. DIMENSION (REF)

=> Please refer to page 3/4.

Notice: Products shown in this leaflet are made for the applications listed below. However, if the above-mentioned products are to be used in aerospace devices, marine cable-connection devices, atomic power control systems, medical equipment for life-support systems, or any other specific application requiring extremely high reliability, please contact JAE for further information.
 Recommended applications: Computers, Office machines, Measuring devices, Telecommunication devices (Terminals, Mobile devices), AV devices, Household applications, FA devices, etc.

Japan Aviation Electronics Industry, Limited

Product Marketing Division
 Aobadai Building, 3-1-19, Aobadai, Meguro-ku, Tokyo 153-8539
 Phone: +81-3-3780-2787 FAX: +81-3-3780-2946

* The specifications in this brochure are subject to change without notice. Please contact JAE for information.